

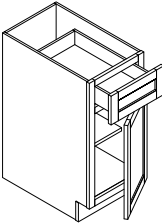
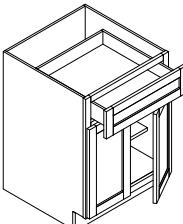
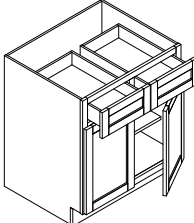
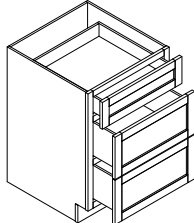
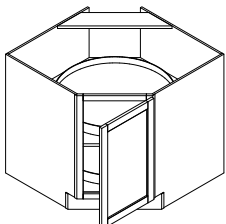
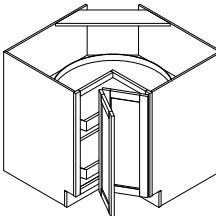
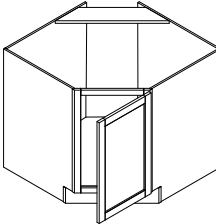
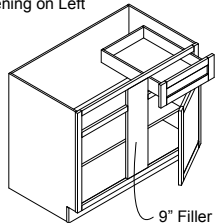
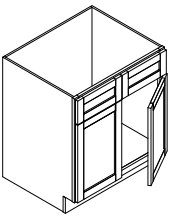
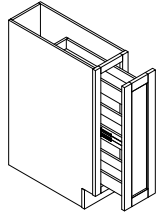
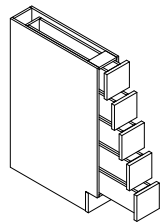
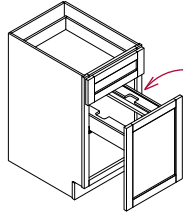

| | | ITEM CODE | K10 | M01 | A7 | K8 / K3 | CO66 | J5 | S1 | S8 | WT/LB | |
|---|--------------------------------------|-----------|-----|-----|----|---------|------|----|----|-------|-------|------|
| BASE CABINET WITH ONE DOOR, ONE DRAWER | | | | | | | | | | | | |
|  | 1 Drawer 1 Door 1 Adj. Shelf | B09 | A | A | A | A | A | A | A | A | 37.0 | |
| | | B12 | A | A | A | A | A | A | A | A | A | 44.0 |
| | | B15 | A | A | A | A | A | A | A | A | A | 46.0 |
| | | B18 | A | A | A | A | A | A | A | A | A | 51.0 |
| | | B21 | A | A | A | A | A | A | A | A | A | 53.0 |
| BASE CABINET WITH TWO DOORS, ONE DRAWER | | | | | | | | | | | | |
|  | 1 Drawer 2 Doors 1 Adj. Shelf | B24 | A | A | A | A | A | A | A | A | 57.0 | |
| | | B27 | A | A | A | A | A | A | A | A | A | 59.0 |
| BASE CABINET WITH TWO DOORS, TWO DRAWERS | | | | | | | | | | | | |
|  | 2 Drawers 2 Doors 1 Adj. Shelf | B30 | A | A | A | A | A | A | A | A | 75.0 | |
| | | B33 | A | A | A | A | A | A | A | A | A | 79.0 |
| | | B36 | A | A | A | A | A | A | A | A | A | 82.5 |
| | | B42 | A | A | A | A | A | A | A | A | A | 92.0 |
| BASE CABINET WITH THREE DRAWERS | | | | | | | | | | | | |
|  | 1 Small Drawer 2 Large Drawers | DB12-3 | A | A | A | A | A | A | A | A | 64.0 | |
| | | DB15-3 | A | A | A | A | A | A | A | A | A | 68.0 |
| | | DB18-3 | A | A | A | A | A | A | A | A | A | 74.0 |
| | | DB21-3 | A | A | A | A | A | A | A | A | A | 79.0 |
| | | DB24-3 | A | A | A | A | A | A | A | A | A | 84.0 |
| | | DB30-3 | A | A | A | A | A | A | A | A | A | 95.0 |
| DB36-3 | A | A | A | A | A | A | A | A | A | 101.0 | | |

| | | ITEM CODE | K10 | M01 | A7 | K8 / K3 | CO66 | J5 | S1 | S8 | WT/LB |
|--|---|-----------|-----|-----|----|---------|------|----|----|----|-------|
| BASE CORNER DIAGONAL CABINET | | | | | | | | | | | |
|  | 1 Full Door: 14-3/4" x 29-1/4" 2 Wooden Round Susans | CBD36 | A | A | A | A | A | A | A | A | 77.0 |
| | | | | | | | | | | | |
| BASE SUPER SUSAN CABINET | | | | | | | | | | | |
|  | 2 Doors: 10-1/2" W x 29-1/4" H 2 Wooden Kidney Shaped Susans | LS3612 | A | A | A | A | A | A | A | A | 77.0 |
| | | | | | | | | | | | |
| BASE DIAGONAL SINK CABINET | | | | | | | | | | | |
|  | 1 Full Door: 14-3/4" x 29-1/4" No Shelf Note: Back Panel Not Cut for Plumbing | CSB36 | A | A | A | A | A | A | A | A | 77.0 |
| | | | | | | | | | | | |
| BASE BLIND CORNER CABINET (L/R) | | | | | | | | | | | |
| Shown BBC42L Opening on Left  | 1 Drawer 1 Door 1 Adj. Shelf Note: Min. 3" Pull Off of the Wall When Install Specify Left or Right When Ordering Assembled 9" Filler | BBC42 | A | A | A | A | A | A | A | A | 72.0 |
| | | | | | | | | | | | |

Note: Style and product availability may vary slightly from those shown in this catalog due to material availability and/or improvements to our designs. Specifications are subject to change without notice. Finger joint technique is used in some of our molding and decorative items, which is acceptable in industry standard. Natural variations of wood make the possibility of the finger joints visible. There is 1/4" to 1/2" deviation on all vanity cabinets. Check with your sales representative for product specification before planning your projects.

A: Available to Order N: Not Available C: Call First

| | | ITEM CODE | K10 | M01 | A7 | K8 / K3 | CO66 | J5 | S1 | S8 | WT/LB | |
|---|---|--|-----|-----|----|---------|------|----|----|----|-------|------|
| SINK BASE CABINET | | | | | | | | | | | | |
|  | 2 Dummy Drawers 2 Doors: No Shelf Note: Back Panel Already Cut for Plumbing | SB30 | A | A | A | A | A | A | A | A | 44.0 | |
| | | SB33 | A | A | A | A | A | A | A | A | A | 46.0 |
| | | SB36 | A | A | A | A | A | A | A | A | A | 47.0 |
| | | SB42 | A | A | A | A | A | A | A | A | A | 48.5 |
| SPICE PULL - OUT BASE CABINET | | | | | | | | | | | | |
|  | Door: 8-3/4" W x 29-1/4" H 3 Wooden Shelves Standard Ball Bearing Side Glide | SP09 | A | A | A | A | A | A | A | A | 38.5 | |
| | | | | | | | | | | | | |
| SPICE DRAWER BASE CABINET | | | | | | | | | | | | |
|  | 5 Square Drawers : 5-3/4" x 5-1/2" No Glides | BWRC6 | A | A | A | A | A | A | A | A | 57.0 | |
| | | | | | | | | | | | | |
| WASTE BIN BASE CABINET | | | | | | | | | | | | |
|  | 1 Drawer 1 Door 1 Bin Cut-out | BWBK18-2 | A | A | A | A | A | A | A | A | 42.0 | |
| | | <div style="text-align: center;"> <p>SOLD SEPARATELY</p>  <p>Item: 6910 (See Pg.45)</p> <p>Plastic Bin Available</p> </div> | | | | | | | | | | |

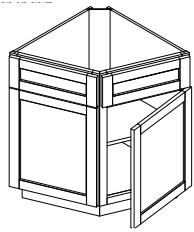
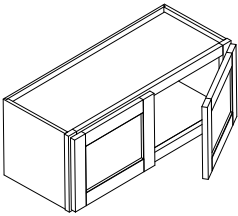
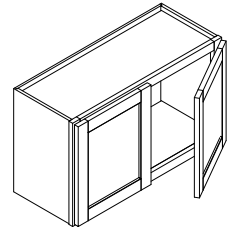
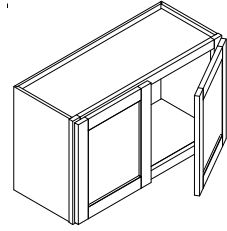
| | | ITEM CODE | K10 | M01 | A7 | K8 / K3 | CO66 | J5 | S1 | S8 | WT/LB |
|---|--|-----------|-----|-----|----|---------|------|----|----|----|-------|
| BASE END CORNER CABINET | | | | | | | | | | | |
|  | 2 Dummy Drawers 2 Doors 1 Adj. Shelf | BEC24 | A | A | A | A | A | A | A | A | 42.0 |
| | | | | | | | | | | | |
| WALL CABINET - 12" H | | | | | | | | | | | |
|  | 2 Doors No Shelf | W3012 | A | A | A | A | A | A | A | A | 19.0 |
| | | W3612 | A | A | A | A | A | A | A | A | A |
| WALL CABINET - 15" H | | | | | | | | | | | |
|  | 2 Doors No Shelf | W3015 | A | A | A | A | A | A | A | A | 22.0 |
| | | W3615 | A | A | A | A | A | A | A | A | A |
| WALL CABINET - 18" H | | | | | | | | | | | |
|  | 2 Doors No Shelf | W3018 | A | A | A | A | A | A | A | A | 24.0 |
| | | W3618 | A | A | A | A | A | A | A | A | A |

A: Available to Order N: Not Available C: Call First

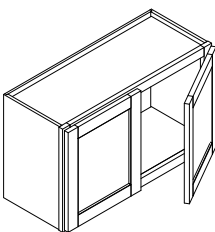
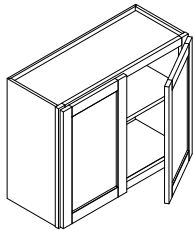
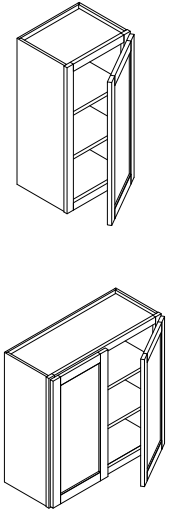
| | | ITEM CODE | K10 | M01 | A7 | K3 / K3 | CO66 | J5 | S1 | S8 | WT/LB |
|--|--|-----------|-----|-----|----|---------|------|----|----|----|-------|
| WALL CABINET - 21" H | | | | | | | | | | | |
|  | 2 Doors No Shelf | W3021 | A | A | A | A | A | A | A | A | 26.0 |
| | | W3621 | A | A | A | A | A | A | A | A | 28.0 |
| WALL CABINET - 24" H | | | | | | | | | | | |
|  | 2 Doors 1 Adj. Shelf | W3024 | A | A | A | A | A | A | A | A | 31.0 |
| | | W3624 | A | A | A | A | A | A | A | A | 38.0 |
| WALL CABINET - 30" H | | | | | | | | | | | |
|  | 9" - 21" W: 1 Door 24" - 42" W: 2 Doors 2 Adj. Shelves | W0930 | A | A | A | A | A | A | A | A | 18.0 |
| | | W1230 | A | A | A | A | A | A | A | A | 22.0 |
| | | W1530 | A | A | A | A | A | A | A | A | 24.0 |
| | | W1830 | A | A | A | A | A | A | A | A | 26.0 |
| | | W2130 | A | A | A | A | A | A | A | A | 31.0 |
| | | W2430 | A | A | A | A | A | A | A | A | 34.0 |
| | | W2730 | A | A | A | A | A | A | A | A | 38.5 |
| | | W3030 | A | A | A | A | A | A | A | A | 41.0 |
| | | W3330 | A | A | A | A | A | A | A | A | 44.0 |
| | | W3630 | A | A | A | A | A | A | A | A | 47.0 |
| | | W4230 | A | A | A | A | A | A | A | A | 51.0 |

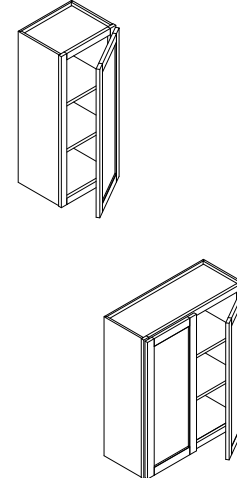
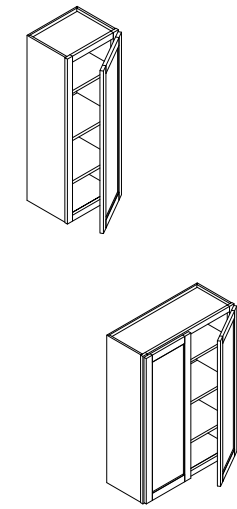
| | | ITEM CODE | K10 | M01 | A7 | K3 / K3 | CO66 | J5 | S1 | S8 | WT/LB |
|--|--|-----------------------------|-----|-----|----|---------|------|----|----|----|-------|
| WALL CABINET - 36" H | | | | | | | | | | | |
|  | 9" - 21" W: 1 Door 24" - 42" W: 2 Doors 2 Adj. Shelves | W0936 | A | A | A | A | A | A | A | A | 21.0 |
| | | W1236 | A | A | A | A | A | A | A | A | 24.0 |
| | | W1536 | A | A | A | A | A | A | A | A | 27.5 |
| | | W1836 | A | A | A | A | A | A | A | A | 31.0 |
| | | W2136 | A | A | A | A | A | A | A | A | 33.0 |
| | | W2436 | A | A | A | A | A | A | A | A | 38.5 |
| | | W2736 | A | A | A | A | A | A | A | A | 43.0 |
| | | W3036 | A | A | A | A | A | A | A | A | 46.0 |
| | | W3336 | A | A | A | A | A | A | A | A | 48.0 |
| | | W3636 | A | A | A | A | A | A | A | A | 51.0 |
| | | W4236 | A | A | A | A | A | A | A | A | 55.0 |
| | | WALL CABINET - 42" H | | | | | | | | | |
|  | 9" - 21" W: 1 Door 24" - 42" W: 2 Doors 3 Adj. Shelves | W0942 | A | A | A | A | A | A | A | A | 23.0 |
| | | W1242 | A | A | A | A | A | A | A | A | 29.0 |
| | | W1542 | A | A | A | A | A | A | A | A | 32.0 |
| | | W1842 | A | A | A | A | A | A | A | A | 36.0 |
| | | W2142 | A | A | A | A | A | A | A | A | 41.0 |
| | | W2442 | A | A | A | A | A | A | A | A | 46.0 |
| | | W2742 | A | A | A | A | A | A | A | A | 51.0 |
| | | W3042 | A | A | A | A | A | A | A | A | 55.0 |
| | | W3342 | A | A | A | A | A | A | A | A | 58.0 |
| | | W3642 | A | A | A | A | A | A | A | A | 60.0 |
| | | W4242 | A | A | A | A | A | A | A | A | 64.0 |

Note: Style and product availability may vary slightly from those shown in this catalog due to material availability and/or improvements to our designs. Specifications are subject to change without notice. Finger joint technique is used in some of our molding and decorative items, which is acceptable in industry standard. Natural variations of wood make the possibility of the finger joints visible. There is 1/4" to 1/2" deviation on all vanity cabinets. Check with your sales representative for product specification before planning your projects.

A: Available to Order N: Not Available C: Call First

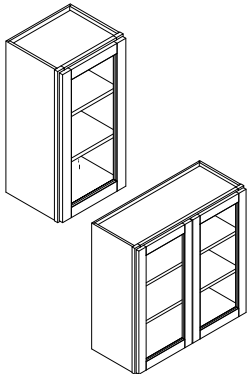
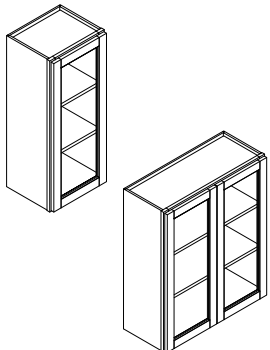
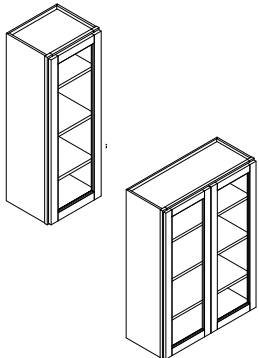
| | | ITEM CODE | K10 | M01 | A7 | K8 / K3 | CO66 | J5 | S1 | S8 | WT/LB | |
|---|--|-----------|-----|-----|----|---------|------|----|----|----|-------|------|
| WALL CABINET - GLASS INSERT - READY - 30" H | | | | | | | | | | | | |
|  | 15" - 18" W: 1 Door 24" - 30" W: 2 Doors 2 Adj. Shelves Not Included Matching Color Interior Note: Glass Shelf & Insert Not Included | WM1530H | A | A | A | A | A | A | A | A | 18.0 | |
| | | WM1830H | A | A | A | A | A | A | A | A | A | 20.0 |
| | | WM2430H | A | A | A | A | A | A | A | A | A | 28.0 |
| | | WM2730H | A | A | A | A | A | A | A | A | A | 29.0 |
| | | WM3030H | A | A | A | A | A | A | A | A | A | 30.0 |
| | | | | | | | | | | | | |
| WALL CABINET - GLASS INSERT - READY - 36" H | | | | | | | | | | | | |
|  | 15" - 18" W: 1 Door 24" - 30" W: 2 Doors 2 Adj. Shelves Not Included Matching Color Interior Note: Glass Shelf & Insert Not Included | WM1536H | A | A | A | A | A | A | A | A | 21.0 | |
| | | WM1836H | A | A | A | A | A | A | A | A | A | 23.3 |
| | | WM2436H | A | A | A | A | A | A | A | A | A | 32.0 |
| | | WM2736H | A | A | A | A | A | A | A | A | A | 33.0 |
| | | WM3036H | A | A | A | A | A | A | A | A | A | 34.0 |
| | | | | | | | | | | | | |
| WALL CABINET - GLASS INSERT - READY - 42" H | | | | | | | | | | | | |
|  | 15" - 18" W: 1 Door 24" - 30" W: 2 Doors 3 Adj. Shelves Not Included Matching Color Interior Note: Glass Shelf & Insert Not Included | WM1542H | A | A | A | A | A | A | A | A | 23.0 | |
| | | WM1842H | A | A | A | A | A | A | A | A | A | 24.0 |
| | | WM2442H | A | A | A | A | A | A | A | A | A | 32.0 |
| | | WM2742H | A | A | A | A | A | A | A | A | A | 38.0 |
| | | WM3042H | A | A | A | A | A | A | A | A | A | 40.0 |
| | | | | | | | | | | | | |

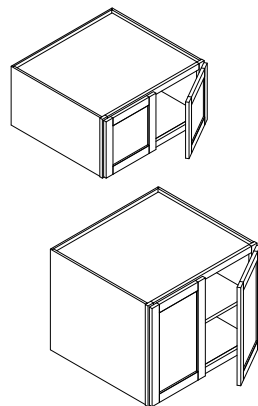
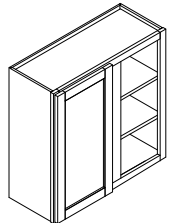
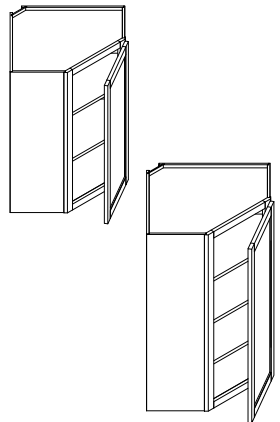
| | | ITEM CODE | K10 | M01 | A7 | K8 / K3 | CO66 | J5 | S1 | S8 | WT/LB | |
|--|---|------------|-----|-----|----|---------|------|----|----|----|-------|------|
| REFRIGERATOR WALL CABINET | | | | | | | | | | | | |
|  | 27" Deep 2 Doors 12" - 21" High: No Shelf 24" High: 1 Adj. Shelf | W361227 | A | A | A | A | A | A | A | A | 36.0 | |
| | | W361527 | A | A | A | A | A | A | A | A | A | 40.0 |
| | | W361827 | A | A | A | A | A | A | A | A | A | 44.0 |
| | | W362127 | A | A | A | A | A | A | A | A | A | 46.0 |
| | | W362427 | A | A | A | A | A | A | A | A | A | 53.0 |
| | | | | | | | | | | | | |
| WALL BLIND CORNER CABINET - L/R | | | | | | | | | | | | |
|  | 1 Door 30" & 36" H: 2 Adj. Shelves 42" H: 3 Adj. Shelves | WCC3030 | C | C | C | C | C | C | C | C | 38.0 | |
| | | WCC3036 | C | C | C | C | C | C | C | C | C | 43.0 |
| | | WCC3042 | C | C | C | C | C | C | C | C | C | 51.0 |
| | | | | | | | | | | | | |
| WALL DIAGONAL CABINET | | | | | | | | | | | | |
|  | 1 Door: 14-3/4" W 30" & 36" High: 2 Adj. shelves 42" High: 3 Adj. Shelves *27" Wide x 15" Deep | WDC2430 | A | A | A | A | A | A | A | A | 48.0 | |
| | | WDC2436 | A | A | A | A | A | A | A | A | A | 51.0 |
| | | WDC2442 | A | A | A | A | A | A | A | A | A | 66.0 |
| | | WDC273615* | A | A | A | A | A | A | A | A | A | 66.0 |
| | | WDC274215* | A | A | A | A | A | A | A | A | A | 76.0 |
| | | | | | | | | | | | | |

A: Available to Order N: Not Available C: Call First

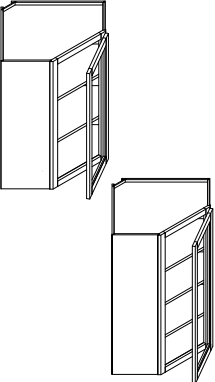
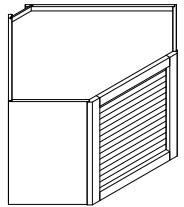
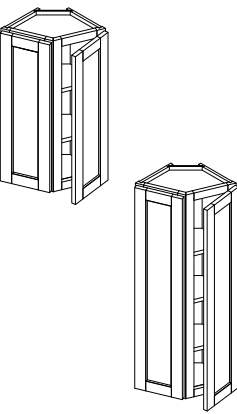
| | | ITEM CODE | K10 | M01 | A7 | K3 / K3 | CO66 | J5 | S1 | S8 | WT/LB |
|--|--|--------------|-----|-----|----|---------|------|----|----|----|-------|
| WALL DIAGONAL CABINET - GLASS INSERT READY | | | | | | | | | | | |
|  | 1 Door: 14-3/4" W 30" & 36" High: 2 Adj. Shelves Not Included 42" High: 3 Adj. Shelves Not Included | WMDC2430H | A | A | A | A | A | A | A | A | 35.0 |
| | | WMDC2436H | A | A | A | A | A | A | A | A | 39.0 |
| | | WMDC2442H | A | A | A | A | A | A | A | A | 44.0 |
| | Matching Color Interior | WMDC273615H* | A | A | A | A | A | A | A | A | 48.0 |
| | *27" Wide x 15" Deep | WMDC274215H* | A | A | A | A | A | A | A | A | 57.0 |
| Note: Glass Shelf & Glass Insert Not Included | | | | | | | | | | | |
| APPLIANCE GARAGE / COUNTER TAMBOUR | | | | | | | | | | | |
|  | All-wood | AG2418 | A | A | A | A | A | A | A | A | 23.0 |
| | Standard 18" High 24", 27" Deep | AG2718 | A | A | A | A | A | A | A | A | 25.0 |
| Note: Use it with Wall Diagonal Cab. Install it after countertop is installed | | | | | | | | | | | |
| WALL END CORNER CABINET | | | | | | | | | | | |
|  | 2 Doors: 8-3/4" W 30" & 36" High: 2 Adj. Shelves 42" High: 3 Adj. Shelves | WEC1230 | A | A | A | A | A | A | A | A | 20.0 |
| | | WEC1236 | A | A | A | A | A | A | A | A | 23.0 |
| | | WEC1242 | A | A | A | A | A | A | A | A | 26.0 |

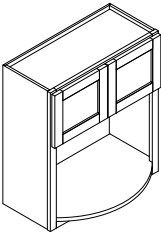
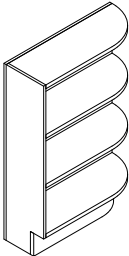
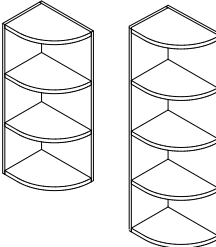
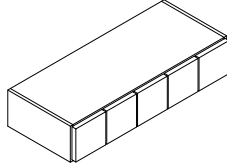

| | | ITEM CODE | K10 | M01 | A7 | K3 / K3 | CO66 | J5 | S1 | S8 | WT/LB |
|---|---|-----------|-----|-----|----|---------|------|----|----|----|-------|
| MICROWAVE CABINET - OPEN SHELF | | | | | | | | | | | |
|  | 2 Doors 1 Open Shelf | WBL2730 | A | A | A | A | A | A | A | A | 35.0 |
| | | WBL2736 | A | A | A | A | A | A | A | A | 38.0 |
| | Opening: 24" W x 16" H Shelf Overhang: 5-1/4" | WBL2742 | A | A | A | A | A | A | A | A | 43.0 |
| BASE END OPEN SHELF (L/R) | | | | | | | | | | | |
|  | 9" W x 24" D 3 Fixed Shelves Matching Color Finish | BES09 | A | A | A | A | A | A | A | A | 36.0 |
| | Specify Left or Right When Ordering Assembly | | | | | | | | | | |
| WALL END OPEN SHELF (L/R) | | | | | | | | | | | |
|  | 9" W x 12" D 30" & 36" High: 3 Fixed Shelves | WES0930 | A | A | A | A | A | A | A | A | 15.0 |
| | | WES0936 | A | A | A | A | A | A | A | A | 17.0 |
| | 42" High: 4 Fixed Shelves | WES0942 | A | A | A | A | A | A | A | A | 20.0 |
| Matching Color Finish | | | | | | | | | | | |
| Note: Curved Molding Not Available | | | | | | | | | | | |
| WALL SPICE DRAWER CABINET | | | | | | | | | | | |
|  | 5 Drawers: 5-3/4" x 5-1/2" 30" Wide 6" High 12" Deep | WWRC6 | A | A | A | A | A | A | A | A | 30.0 |

Note: Style and product availability may vary slightly from those shown in this catalog due to material availability and/or improvements to our designs. Specifications are subject to change without notice. Finger joint technique is used in some of our molding and decorative items, which is acceptable in industry standard. Natural variations of wood make the possibility of the finger joints visible. There is 1/4" to 1/2" deviation on all vanity cabinets. Check with your sales representative for product specification before planning your projects.

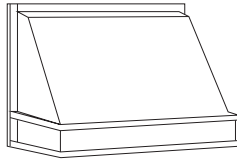
A: Available to Order N: Not Available C: Call First

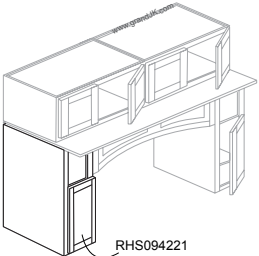
| | | ITEM CODE | K10 | M01 | A7 | K8 / K3 | CO66 | J5 | S1 | S8 | WT/LB |
|---|--------------------------------------|-----------|-----|-----|----|---------|------|----|----|----|-------|
| TAPERED WOOD HOOD | | | | | | | | | | | |
|  | 36", 42" Wide 24" High 9" Deep | RHE3624 | C | C | C | C | C | C | C | C | 28.5 |
| | | RHE4224 | C | C | C | C | C | C | C | C | C |

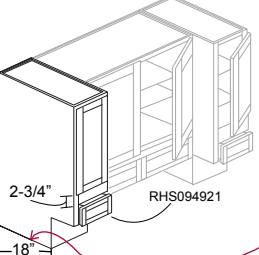
| HEARTH HOOD PIER | | | | | | | | | | | |
|---|--|-----------|---|---|---|---|---|---|---|---|------|
|  | 9" Wide 42" High 21" Deep On Countertop | RHS094221 | C | C | C | C | C | C | C | C | 31.0 |
| | | | | | | | | | | | |

| HEARTH HOOD PIER - WALL HUNG | | | | | | | | | | | |
|--|--|--|---|---|---|---|---|---|---|---|------|
|  | 9" Wide 49" High 21" Deep On the Wall | RHS094921 | C | C | C | C | C | C | C | C | 41.0 |
| | | SOLD SEPERATELY  | | | | | | | | | |
| <p>Note: Cut to 15" to Fit Corbels</p> | | | | | | | | | | | |

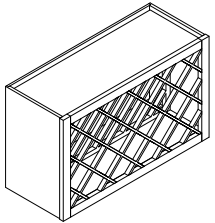
| WINE RACK | | | | | | | | | | | |
|---|---|------|---|---|---|---|---|---|---|---|------|
|  | 15" High 30WR: 10 Compartments 36WR: 14 Compartments Matching Color Finish | 30WR | A | A | A | A | A | A | A | A | 19.0 |
| | | 36WR | A | A | A | A | A | A | A | A | A |

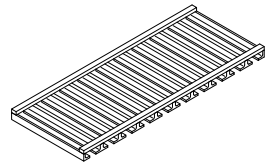
| | | ITEM CODE | K10 | M01 | A7 | K8 / K3 | CO66 | J5 | S1 | S8 | WT/LB |
|---|--|-----------|-----|-----|----|---------|------|----|----|----|-------|
| GLASS RACK | | | | | | | | | | | |
|  | All-wood 1-1/2" High Matching Color Finish | 30GR | A | A | A | A | A | A | A | A | 4.5 |
| | | 36GR | A | A | A | A | A | A | A | A | A |

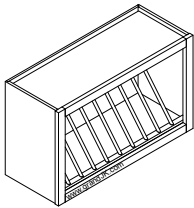
| PLATE RACK CABINET | | | | | | | | | | | |
|---|---|---------|---|---|---|---|---|---|---|---|------|
|  | All-wood 18" H with 15" H Opening WCD3018: 10 Plates WCD3618: 12 Plates Matching Color Finish | WCD3018 | A | A | A | A | A | A | A | A | 19.0 |
| | | WCD3618 | A | A | A | A | A | A | A | A | A |

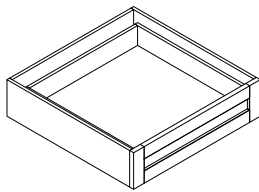
| KNEE DRAWER | | | | | | | | | | | |
|---|--|------|---|---|---|---|---|---|---|---|------|
|  | 21" Deep 1 Drawer Box: 7-1/2" H on A7, M01, K10, K8, K3 Box: 8-1/2" H on CO66, J5, S1, S8 | FD24 | A | A | A | A | A | A | A | A | 25.0 |
| | | FD30 | A | A | A | A | A | A | A | A | A |

| ROLL-OUT TRAY - STANDARD SIDE GLIDE | | | | | | | | | | | | |
|---|--|------|---|---|---|---|---|---|---|------|-----|------|
|  | Clear Coat Finish 3-3/4" H Ball Bearing Side Glides Included, for 24" Deep Cabinets Only Note: 26" Glide Sold Separately for 27" Deep Pantry | RD15 | A | A | A | A | A | A | A | A | 9.0 | |
| | | RD18 | A | A | A | A | A | A | A | A | A | 10.0 |
| | | RD21 | A | A | A | A | A | A | A | A | A | 11.0 |
| | | RD24 | A | A | A | A | A | A | A | A | A | 11.0 |
| | | RD27 | A | A | A | A | A | A | A | A | A | 11.0 |
| | | RD30 | A | A | A | A | A | A | A | A | A | 13.0 |
| | | RD33 | A | A | A | A | A | A | A | A | A | 15.0 |
| RD36 | A | A | A | A | A | A | A | A | A | 16.0 | | |

A: Available to Order N: Not Available C: Call First

PANTRY CABINET-WITH ROLL-OUT TRAYS

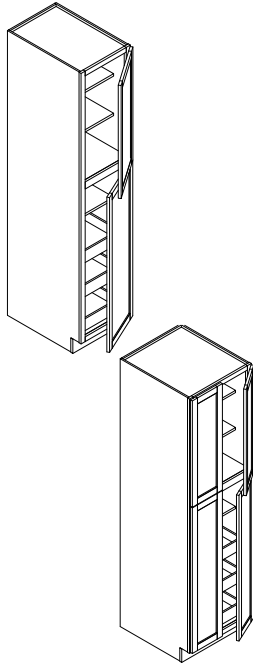

18" Wide: 2 Doors
24" & 30" Wide: 4 Doors

3 Roll Outs with Ball Bearing Glide

1 Shelf in the Bottom Box

84" & 90" H: 2 Adj. Shelves in the Top Box

96" H: 3 Adj. Shelves in the Top Box

Upper Door: 30", 36", 42" H
Lower Door: 49-1/2" H

| ITEM CODE | K10 | M01 | A7 | K8 / K3 | CO66 | J5 | S1 | S8 | WT/LB |
|-----------|-----|-----|----|---------|------|----|----|----|-------|
| WP188427 | A | A | A | A | A | A | A | A | 120.0 |
| WP189027 | A | A | A | A | A | A | A | A | 135.0 |
| WP189627 | A | A | A | A | A | A | A | A | 143.0 |
| WP248427 | A | A | A | A | A | A | A | A | 150.0 |
| WP249027 | A | A | A | A | A | A | A | A | 156.0 |
| WP249627 | A | A | A | A | A | A | A | A | 170.0 |
| WP308427 | A | A | A | A | A | A | A | A | 178.0 |
| WP309027 | A | A | A | A | A | A | A | A | 185.0 |
| WP309627 | A | A | A | A | A | A | A | A | 192.0 |

OVEN CABINET-SINGLE

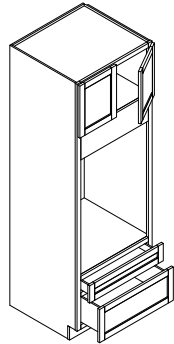

27" Deep
2 Doors: 12", 18", 24" H

Upper Rail: 10-1/2" H
Lower Rail: See Table Below

Stile: 1-1/2" W on 30" Cab.
2-1/8" W on 33" Cab.

Note: Trim or Add to Fit Oven

| Lower Rail Dimension | |
|----------------------|----------|
| K10, M01, A7, K8, K3 | 2-7/8" W |
| J5, CO66, S1, S8 | 3" W |

| ITEM CODE | K10 | M01 | A7 | K8 / K3 | CO66 | J5 | S1 | S8 | WT/LB |
|-----------|-----|-----|----|---------|------|----|----|----|-------|
| OC308427 | C | C | C | C | C | C | C | C | 144.0 |
| OC309027 | A | A | A | A | A | A | A | A | 152.0 |
| OC309627 | A | A | A | A | A | A | A | A | 152.0 |
| OC338427 | C | C | C | C | C | C | C | C | 157.0 |
| OC339027 | A | A | A | A | A | A | A | A | 160.0 |
| OC339627 | A | A | A | A | A | A | A | A | 185.0 |

K10, M01, A7, K8, K3, J5, CO66, S1, S8

| | |
|-------------------------|-----------------------|
| 30" Cab. Actual Opening | 27" W x 38-1/2" H |
| 33" Cab. Actual Opening | 28-3/4" W x 38-1/2" H |

| Drawers | Upper | Lower |
|----------------------|-------|-----------|
| K10, M01, A7, K8, K3 | 6" H | 11-3/8" H |
| J5, CO66, S1, S8 | 7" H | 10-7/8" H |

OVEN CABINET-DOUBLE

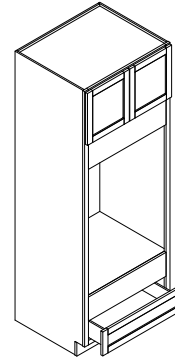

27" Deep
1 Drawer: 7-1/2" H
2 Doors: 12", 18", 24" H

Upper Rail: 9-1/4" H
Lower Rail: 9-1/4" H

Stile: 1-1/2" W on 30" Cab.
2-1/8" W on 33" Cab.

Note: Trim or Add to Fit Oven

K10, M01, A7, K8, K3

| | |
|-------------------------|------------------------|
| 30" Cab. Actual Opening | 27" W x 43-7/16" H |
| 33" Cab. Actual Opening | 28-3/4" W x 43-7/16" H |

J5, CO66, S1, S8

| | |
|-------------------------|-----------------------|
| 30" Cab. Actual Opening | 27" W x 43-1/2" H |
| 33" Cab. Actual Opening | 28-3/4" W x 43-1/2" H |

| ITEM CODE | K10 | M01 | A7 | K8 / K3 | CO66 | J5 | S1 | S8 | WT/LB |
|------------|-----|-----|----|---------|------|----|----|----|-------|
| OC308427WO | C | C | C | C | C | C | C | C | 124.0 |
| OC309027WO | A | A | A | A | A | A | A | A | 130.0 |
| OC309627WO | A | A | A | A | A | A | A | A | 143.0 |
| OC338427WO | C | C | C | C | C | C | C | C | 132.0 |
| OC339027WO | A | A | A | A | A | A | A | A | 141.0 |
| OC339627WO | A | A | A | A | A | A | A | A | 145.0 |

DUMMY DOOR - FULL DOOR

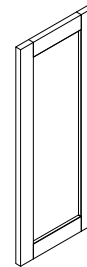

12", 15", 21" 24" Wide

28", 30", 36", 42" High

3/4" Thick

*21" W x 28" H (Vanity)

Predrilled Hinge Holes

| | | | | | | | | | |
|--------|---|---|---|---|---|---|---|---|-----|
| W1230F | A | A | A | A | A | A | A | A | 5.0 |
| W1236F | A | A | A | A | A | A | A | A | 6.0 |
| W1242F | A | A | A | A | A | A | A | A | 7.0 |
| W1530F | C | C | C | C | C | C | C | C | 5.5 |
| W1536F | C | C | C | C | C | C | C | C | 6.5 |
| W1542F | C | C | C | C | C | C | C | C | 7.5 |
| BDD21* | C | C | C | C | C | C | C | C | 6.0 |
| BDD24 | A | A | A | A | A | A | A | A | 7.0 |

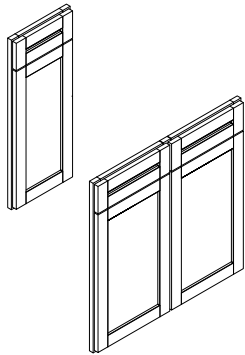
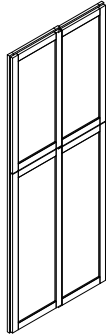
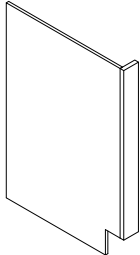

Note: Style and product availability may vary slightly from those shown in this catalog due to material availability and/or improvements to our designs. Specifications are subject to change without notice. Finger joint technique is used in some of our molding and decorative items, which is acceptable in industry standard. Natural variations of wood make the possibility of the finger joints visible. There is 1/4" to 1/2" deviation on all vanity cabinets. Check with your sales representative for product specification before planning your projects.

A: Available to Order N: Not Available C: Call First

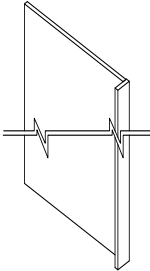
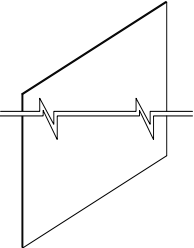
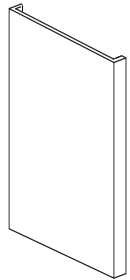
| | | ITEM CODE | K10 | M01 | A7 | K8 / K3 | CO66 | J5 | S1 | S8 | WT/LB |
|---|--|-----------|-----|-----|----|---------|------|----|----|------|-------|
| DUMMY DOOR & DRAWER | | | | | | | | | | | |
|  | 30" High 1-1/2" Thick Face-frame Attached B18F: 1 DR, 1 DRW B30F: 2 DR, 2 DRW B36F: 2 DR, 2 DRW | B18F | A | A | A | A | A | A | A | 11.0 | |
| | | B30F | A | A | A | A | A | A | A | A | 18.0 |
| | | B36F | A | A | A | A | A | A | A | A | 24.0 |
| | | | | | | | | | | | |
| DUMMY DOOR - TALL DOORS | | | | | | | | | | | |
|  | 4 Dummy Doors 84" 90", 96" High 24", 27" Deep 3/4" Thick No Face-frame Use It for Tall Cabinets Predrilled Hinge Holes | BDD8424 | C | C | C | C | C | C | C | 46.0 | |
| | | BDD9024 | C | C | C | C | C | C | C | C | 51.0 |
| | | BDD9624 | C | C | C | C | C | C | C | C | 54.0 |
| | | | | | | | | | | | |
| | | BDD8427 | C | C | C | C | C | C | C | C | 48.0 |
| | | BDD9027 | C | C | C | C | C | C | C | C | 52.0 |
| | | BDD9627 | C | C | C | C | C | C | C | C | 55.0 |
| DISHWASHER RETURN PANEL | | | | | | | | | | | |
|  | 3" Return Filler 23-1/4" Deep Panel 34-1/2" High Note: Not Assembled & Toe Kick Not Included | DWR (L/R) | A | A | A | A | A | A | A | 9.5 | |
| | | | | | | | | | | | |

| | | ITEM CODE | K10 | M01 | A7 | K8 / K3 | CO66 | J5 | S1 | S8 | WT/LB |
|--|--|--------------|-----|-----|----|---------|------|----|----|------|-------|
| REFRIGERATOR RETURN PANEL | | | | | | | | | | | |
|  | 3" Return Filler 26-1/4" Deep Panel 84", 90", 96" High Optional 1-1/2" Return Filler Sold Separately (Item Code: CM34-1 1/2) Note: Not Assembled No Return Filler, 4 Sides Edge Banded, 27" W x 96" H | RRP8427 | A | A | A | A | A | A | A | 26.0 | |
| | | RRP9027 | A | A | A | A | A | A | A | A | 28.4 |
| | | RRP9627 | A | A | A | A | A | A | A | A | 30.0 |
| | | *RRP9627*3/4 | C | C | C | C | C | C | C | C | 25.00 |
| FINISHED SKIN PANEL | | | | | | | | | | | |
|  | 1/4" Thick 36" Wide 96" High BP3696: Short Grain BP9636: Long Grain | BP3696 | A | A | A | A | A | A | A | 13.2 | |
| | | BP9636 | A | A | A | A | A | A | A | A | 13.2 |
| | | | | | | | | | | | |
| FILLER RETURN PANEL | | | | | | | | | | | |
|  | 3" Wide Return Filler 15" Deep 30", 36", 42" High | DER30F | C | C | C | C | C | C | N | 18.0 | |
| | | DER36F | C | C | C | C | C | C | C | N | 24.0 |
| | | DER42F | C | C | C | C | C | C | C | N | 30.0 |
| | | | | | | | | | | | |

A: Available to Order N: Not Available C: Call First

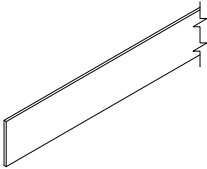
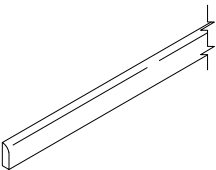
| | | ITEM CODE | K10 | M01 | A7 | K3 / K3 | CC66 | J5 | S1 | S8 | WT/LB | |
|---|---|-----------|-----|-----|----|---------|------|----|----|----|-------|-----|
| WALL FILLER | | | | | | | | | | | | |
|  | All-wood 3", 6,12" Wide 30", 36", 42" High Matching Finish on One Side | WF330 | A | A | A | A | A | A | A | A | 1.5 | |
| | | WF336 | A | A | A | A | A | A | A | A | 2.0 | |
| | | WF342 | A | A | A | A | A | A | A | A | A | 2.5 |
| | | WF630 | A | A | A | A | A | A | A | A | A | 2.0 |
| | | WF636 | A | A | A | A | A | A | A | A | A | 3.5 |
| | | WF642 | A | A | A | A | A | A | A | A | A | 4.5 |
| | | WF1236 | A | A | A | A | A | A | A | A | A | 7.0 |
| BASE FILLER | | | | | | | | | | | | |
|  | All-wood 3" or 6" Filler Toe-Kick Attached | BF3 | A | A | A | A | A | A | A | A | 2.5 | |
| | | BF6 | A | A | A | A | A | A | A | A | A | 5.0 |
| TOE KICK | | | | | | | | | | | | |
|  | 4-1/2" Wide 1/4" Thick 96" Long | TK8 | A | A | A | A | A | A | A | A | 0.8 | |
| | | | | | | | | | | | | |
| SCRIBE MOLDING | | | | | | | | | | | | |
|  | 3/4" Wide 1/4" Thick 96" Long | SM8 | A | A | A | A | A | A | A | A | 0.5 | |
| | | | | | | | | | | | | |

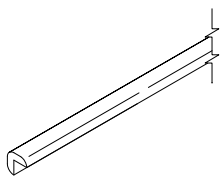
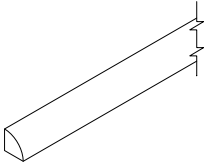
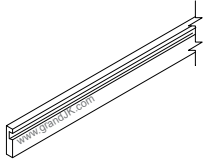
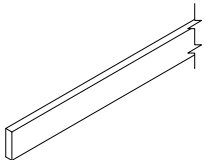
| | | ITEM CODE | K10 | M01 | A7 | K3 / K3 | CC66 | J5 | S1 | S8 | WT/LB | |
|---|---|-------------|-----|-----|----|---------|------|----|----|----|-------|------|
| OUTSIDE CORNER MOLDING | | | | | | | | | | | | |
|  | 3/4" Deep 3/4" Wide 1/4" Thick 96" Long | OCM8 | A | A | A | A | A | A | A | A | 0.7 | |
| | | | | | | | | | | | | |
| QUARTER ROUND MOLDING | | | | | | | | | | | | |
|  | 3/4" Deep 3/4" Wide 120" Long | QRM10 | A | A | A | A | A | A | A | A | 2.0 | |
| | | | | | | | | | | | | |
| FACE FRAME DADO-FILLER | | | | | | | | | | | | |
|  | 1-1/2" Wide 3/4" Thick 120" Long Note: Good for Ref. Panel & Semi-Custom Cabinet | CM34- 1 1/2 | A | A | A | A | A | A | A | A | 2.5 | |
| | | | | | | | | | | | | |
| TALL FILLER | | | | | | | | | | | | |
|  | 3", 6" Wide 3/4" Thick 120" Long *CM34-9: 9" W x 84" Long | CM34-3 | A | A | A | A | A | A | A | A | 5.0 | |
| | | CM34-6 | A | A | A | A | A | A | A | A | A | 10.0 |
| | | *CM34-9 | C | C | C | C | C | C | C | C | C | 15.0 |

Note: Style and product availability may vary slightly from those shown in this catalog due to material availability and/or improvements to our designs. Specifications are subject to change without notice. Finger joint technique is used in some of our molding and decorative items, which is acceptable in industry standard. Natural variations of wood make the possibility of the finger joints visible. There is 1/4" to 1/2" deviation on all vanity cabinets. Check with your sales representative for product specification before planning your projects.

A: Available to Order N: Not Available C: Call First

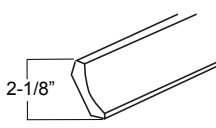
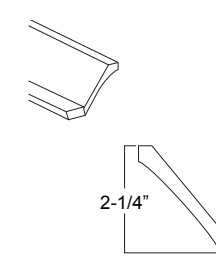
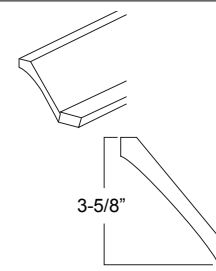
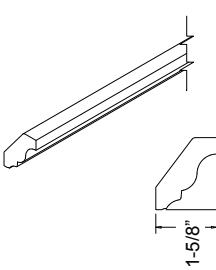
| | | ITEM CODE | K10 | M01 | A7 | K8 / K3 | CO66 | J5 | S1 | S8 | WT/LB |
|---|--|-------------|-----|-----|----|---------|------|----|----|----|-------|
| COVE MOLDING | | | | | | | | | | | |
|  | Standing Height: 2-1/4" Standing Depth: 2-1/8" 120" Long | ST10 | C | C | C | C | C | C | A | A | 9.5 |
| COVE MOLDING - WITH BASE - SMALL | | | | | | | | | | | |
|  | Standing Height: 2-1/4" Standing Depth: 3-7/8" 120" Long | AST10 3-1/4 | C | C | C | C | C | C | A | A | 10.0 |
| COVE MOLDING - WITH BASE - LARGE | | | | | | | | | | | |
|  | Standing Height: 3-5/8" Standing Depth: 5-1/4" 120" Long | AST10 5-1/4 | C | C | C | C | C | C | A | A | 12.0 |
| CROWN MOLDING | | | | | | | | | | | |
|  | Standing Height: 2-1/8" Standing Depth: 1-5/8" 120" Long | CM10 | C | C | C | C | C | C | N | N | 9.5 |

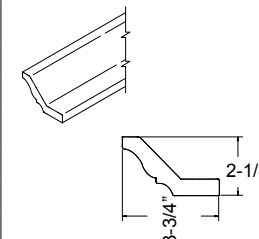
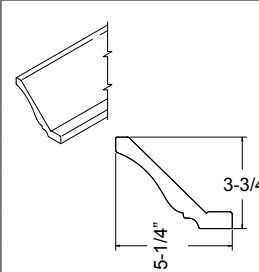
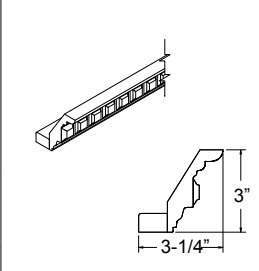
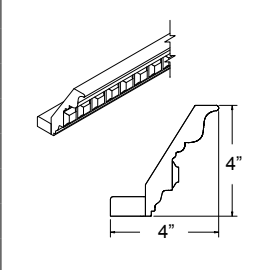
| | | ITEM CODE | K10 | M01 | A7 | K8 / K3 | CO66 | J5 | S1 | S8 | WT/LB |
|---|--|-------------|-----|-----|----|---------|------|----|----|----|-------|
| CROWN MOLDING - WITH BASE - SMALL | | | | | | | | | | | |
|  | Standing Height: 2-1/8" Standing Depth: 3-3/4" 120" Long | ACM10 3-1/4 | A | A | A | A | A | A | N | N | 10.0 |
| CROWN MOLDING - WITH BASE - LARGE | | | | | | | | | | | |
|  | Standing Height: 3-3/4" Standing Depth: 5-1/4" 120" Long | ACM10 5-1/4 | A | A | A | A | A | A | N | N | 12.0 |
| CROWN DENTIL MOLDING - WITH BASE - SMALL | | | | | | | | | | | |
|  | Standing Height: 3" Standing Depth: 3-1/4" 120" Long | CCM10-B | A | A | A | A | A | A | N | N | 11.0 |
| CROWN DENTIL MOLDING - WITH BASE - LARGE | | | | | | | | | | | |
|  | Standing Height: 4" Standing Depth: 4" 120" Long | CCM10-A | A | A | A | A | A | A | N | N | 13.0 |

A: Available to Order N: Not Available C: Call First

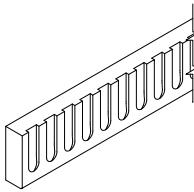
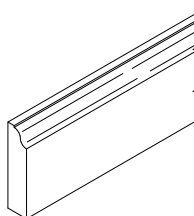
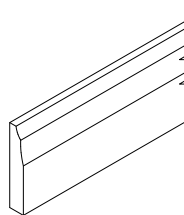
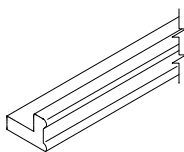
| | | ITEM CODE | K10 | M01 | A7 | K3 / K3 | CC66 | J5 | S1 | S8 | WT/LB |
|---|---|-----------|-----|-----|----|---------|------|----|----|----|-------|
| DENTIL MOLDING | | | | | | | | | | | |
|  | 2-1/4" Wide 3/4" Thick 120" Long | WDM10 | A | A | A | A | A | A | N | N | 4.5 |
| OGEE MOLDING | | | | | | | | | | | |
|  | 3" Wide 3/4" Thick 120" Long | OGM10 | A | A | A | A | A | A | A | A | 5.5 |
| BASE MOLDING | | | | | | | | | | | |
|  | 4" Wide 3/4" Thick 120" Long | BM10 | A | A | A | A | A | A | A | A | 4.5 |
| LIGHT RAIL MOLDING | | | | | | | | | | | |
|  | 1-1/2" Wide 2-1/4" Deep 120" Long | TLR10-A | A | A | A | A | A | A | A | A | 10.0 |

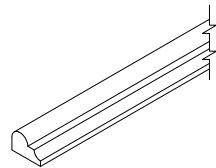
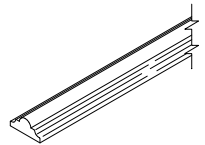
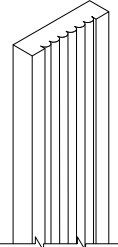
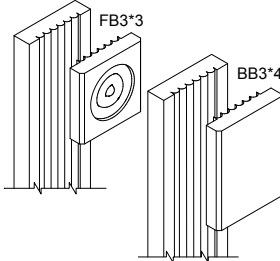
| | | ITEM CODE | K10 | M01 | A7 | K3 / K3 | CC66 | J5 | S1 | S8 | WT/LB |
|---|---|-----------|-----|-----|----|---------|------|----|----|----|-------|
| CHAIR RAIL MOLDING - 1/2 | | | | | | | | | | | |
|  | 1-1/8" Wide 3/4" Thick 120" Long | CR10 | A | A | A | A | A | A | A | A | 2.0 |
| CHAIR RAIL MOLDING | | | | | | | | | | | |
|  | 1-5/8" Wide 3/4" Thick 120" Long | FSM10 | A | A | A | A | A | A | A | A | 4.0 |
| FLUTED FILLER | | | | | | | | | | | |
|  | 3" Wide 3/4" Thick 96" Long | PCVFF3 | A | A | A | A | A | A | A | A | 4.0 |
| FLUTED BLOCK | | | | | | | | | | | |
|  | Plinth - BB3*4: 3" W x 4" H Rosette - FB3*3: 3" W x 3" H | BB3*4 | A | A | A | A | A | A | A | A | 0.5 |
| | | FB3*3 | A | A | A | A | A | A | A | A | 0.5 |

Note: Style and product availability may vary slightly from those shown in this catalog due to material availability and/or improvements to our designs. Specifications are subject to change without notice. Finger joint technique is used in some of our molding and decorative items, which is acceptable in industry standard. Natural variations of wood make the possibility of the finger joints visible. There is 1/4" to 1/2" deviation on all vanity cabinets. Check with your sales representative for product specification before planning your projects.

A: Available to Order N: Not Available C: Call First

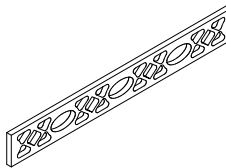
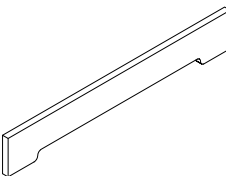
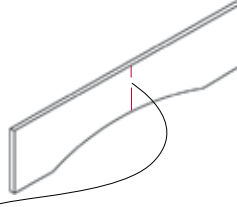
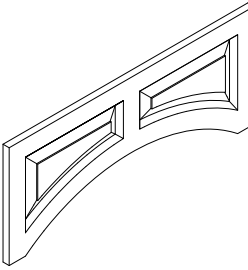
| | | ITEM CODE | K10 | M01 | A7 | K8 / K3 | CO66 | J5 | S1 | S8 | WT/LB | |
|---|---|-----------|-----|-----|----|---------|------|----|------|-----|-------|-----|
| FRIEZE VALANCE | | | | | | | | | | | | |
|  | 4-1/2" Wide 3/4" Thick 30" - 60" Long | V30A | A | A | A | A | A | N | N | | 1.5 | |
| | | V36A | A | A | A | A | A | A | N | N | | 2.0 |
| | | V42A | A | A | A | A | A | A | N | N | | 2.5 |
| | | V54A | A | A | A | A | A | A | N | N | | 4.0 |
| | | V60A | A | A | A | A | A | A | N | N | | 5.0 |
| ARCH VALANCE | | | | | | | | | | | | |
|  | 4-1/2" Wide 3/4" Thick 30"-60" Long | V30B | A | A | A | A | A | A | A | | 1.5 | |
| | | V36B | A | A | A | A | A | A | A | A | | 2.0 |
| | | V42B | A | A | A | A | A | A | A | A | | 2.5 |
| | | V48B | A | A | A | A | A | A | A | A | | 3.0 |
| | | V54B | A | A | A | A | A | A | A | A | | 4.0 |
| V60B | A | A | A | A | A | A | A | A | | 5.0 | | |
| ARCH VALANCE - FLATE LARGE | | | | | | | | | | | | |
|  | 36" - 60" Wide 8" High 3/4" Thick *15" High Note: Finger Joined Panel | RPV36 | C | C | C | C | C | C | C | | 4.0 | |
| | | RPV42 | C | C | C | C | C | C | C | | 5.0 | |
| | | RPV54 | C | C | C | C | C | C | C | | 8.0 | |
| | | RPV60* | C | C | C | C | C | C | C | | 10.0 | |
| Center: 5" & 8-1/4" for RPV60 | | | | | | | | | | | | |
| ARCH VALANCE- LARGE RAISED PANEL | | | | | | | | | | | | |
|  | 36"-72" Long 3/4" Thick 15" High 4-1/2" Arch Height | RPV36-A | C | C | C | C | C | C | C | | 6.0 | |
| | | RPV42-A | C | C | C | C | C | C | C | | 7.0 | |
| | | RPV48-A | C | C | C | C | C | C | C | | 9.0 | |
| | | RPV54-A | C | C | C | C | C | C | C | | 10.0 | |
| | | RPV60-A | C | C | C | C | C | C | C | | 12.0 | |
| RPV72-A | C | C | C | C | C | C | C | | 15.0 | | | |

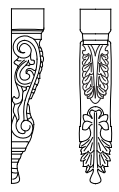
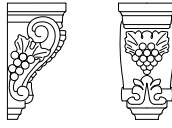
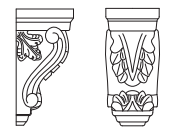
| | | ITEM CODE | K10 | M01 | A7 | K8 / K3 | CO66 | J5 | S1 | S8 | WT/LB |
|---|------------------------------------|-----------|-----|-----|----|---------|------|----|----|----|-------|
| CORBEL - TALL GRAPE | | | | | | | | | | | |
|  | 3-1/2" Wide 3" Deep 18" High | OLC318 | A | A | A | A | A | A | N | N | 2.0 |
| | | | | | | | | | | | |
| CORBEL - TALL ACANTHUS | | | | | | | | | | | |
|  | 3-1/2" Wide 3" Deep 18" High | RLC318 | A | A | A | A | A | A | N | N | 2.0 |
| | | | | | | | | | | | |
| CORBEL - WIDE GRAPE | | | | | | | | | | | |
|  | 4-1/2" Wide 5" Deep 10" High | GC58 | A | A | A | A | A | A | N | N | 3.0 |
| | | | | | | | | | | | |
| CORBEL - WIDE ACANTHUS | | | | | | | | | | | |
|  | 4-1/2" Wide 5" Deep 10" High | RC58 | A | A | A | A | A | A | N | N | 3.0 |
| | | | | | | | | | | | |

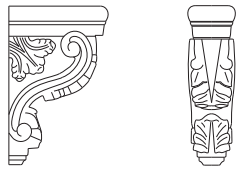
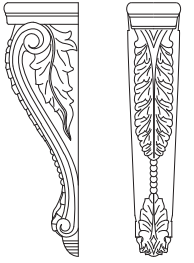
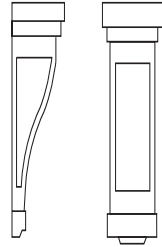

A: Available to Order N: Not Available C: Call First

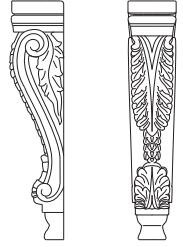
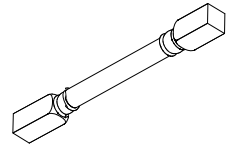
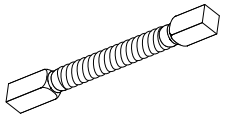
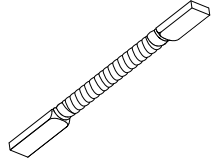
| | | ITEM CODE | K10 | M01 | A7 | K8 / K3 | CC66 | J5 | S1 | S8 | WT/LB |
|---|--|-----------|-----|-----|----|---------|------|----|----|----|-------|
| CORBEL - WIDE MISSION | | | | | | | | | | | |
|  | 4-1/2" Wide 5" Deep 10-1/2" High | SC58 | C | C | C | C | C | C | C | C | 3.0 |
| CORBEL - NARROW ACANTHUS | | | | | | | | | | | |
|  | 3-1/2" Wide 8-1/4" Deep 13" High | RC313 | A | A | A | A | A | A | N | N | 8.0 |
| CORBEL - LARGE ACANTHUS | | | | | | | | | | | |
|  | 5-1/2" Wide 7-1/2" Deep 30" High | RC530 | A | A | A | A | A | A | N | N | 27.0 |
| CORBEL - LARGE MISSION | | | | | | | | | | | |
|  | 5-1/2" Wide 7" Deep 30" High | SC530 | C | C | C | C | C | C | C | C | 27.0 |

| | | ITEM CODE | K10 | M01 | A7 | K8 / K3 | CC66 | J5 | S1 | S8 | WT/LB |
|---|--|------------|-----|-----|----|---------|------|----|----|----|-------|
| CORBEL - EXTRA LARGE ACANTHUS | | | | | | | | | | | |
|  | 6-1/4" Wide 8-1/2" Deep 34-1/2" High | CB34 1/2A | A | A | A | A | A | A | N | N | 29.0 |
| POST - FULL TRADITIONAL | | | | | | | | | | | |
|  | 3" Wide 3" Deep 34-1/2" High | SP3X34 1/2 | A | A | A | A | A | A | A | A | 5.0 |
| POST - FULL ROPE | | | | | | | | | | | |
|  | 3" Wide 3" Deep 34-1/2" High | RP34 1/2 | A | A | A | A | A | A | N | N | 5.0 |
| POST - SPLIT ROPE | | | | | | | | | | | |
|  | 2" Wide 3/4" Thick 18" - 42" High | RPS18 | A | A | A | A | A | A | C | C | 0.5 |
| | | RPS24 | A | A | A | A | A | A | C | C | 1.0 |
| | | RPS30 | A | A | A | A | A | A | C | C | 1.5 |
| | | RPS36 | A | A | A | A | A | A | C | C | 1.8 |
| | | RPS42 | A | A | A | A | A | A | C | C | 2.1 |

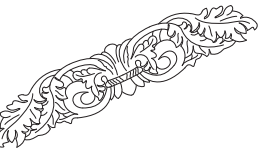
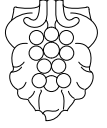

Note: Style and product availability may vary slightly from those shown in this catalog due to material availability and/or improvements to our designs. Specifications are subject to change without notice. Finger joint technique is used in some of our molding and decorative items, which is acceptable in industry standard. Natural variations of wood make the possibility of the finger joints visible. There is 1/4" to 1/2" deviation on all vanity cabinets. Check with your sales representative for product specification before planning your projects.

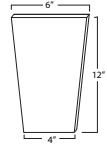
A: Available to Order N: Not Available C: Call First

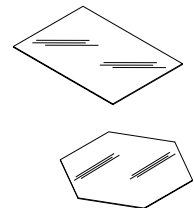
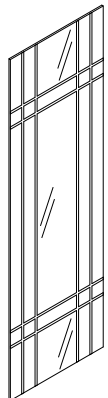
| | | ITEM CODE | K10 | M01 | A7 | K8 / K3 | CO66 | J5 | S1 | S8 | WT/LB |
|---|--|-----------|-----|-----|----|---------|------|----|----|----|-------|
| ONLY - GRAPE | | | | | | | | | | | |
|  | 20" Wide 3/4" Thick 4-1/2" High | GRPO | A | A | A | A | A | A | N | N | 1.0 |
| ONLY - LEAF | | | | | | | | | | | |
|  | 20" Wide 3/4" Thick 4-1/2" High | RRPO | A | A | A | A | A | A | N | N | 1.0 |
| ONLY - SMALL GRAPE ORNAMENT | | | | | | | | | | | |
|  | 3" Wide 4" High 3/4" Thick | SGO | A | A | A | A | A | A | N | N | 0.5 |
| ONLY - SMALL LEAF ORNAMENT | | | | | | | | | | | |
|  | 3" Wide 4" High 3/4" Thick | RGO | A | A | A | A | A | A | N | N | 0.5 |
| KEY STONE | | | | | | | | | | | |
|  | Top 6" W & Bottom 4" W 12" High 3/4" Thick | CO12 | C | C | C | C | C | C | C | C | 1.0 |

| | | ITEM CODE | K10 | M01 | A7 | K8 / K3 | CO66 | J5 | S1 | S8 | WT/LB | |
|---|---|--------------------------------|-----|-----|----|---------|------|----|----|-----|-------|-----|
| GLASS SHELF - NOT TEMPERED | | | | | | | | | | | | |
|  | Use on WM****H Cab. Note: Caution When Shipping | GS-15 (WM1530/36/42H) | A | A | A | A | A | A | A | A | 6.0 | |
| | | GS-18 (WM1830/36/42H) | A | A | A | A | A | A | A | A | 8.0 | |
| | | GS-24 (WM2430/36/42H) | A | A | A | A | A | A | A | A | 8.5 | |
| | | GS-27 (WM2730/36/42H) | A | A | A | A | A | A | A | A | 9.0 | |
| | | GS-30 (WM3030/36/42H) | A | A | A | A | A | A | A | A | 9.5 | |
| | | GS-WDC24*12 (WDC2430/36/42H) | A | A | A | A | A | A | A | A | 10.0 | |
| | | GS-WDC27*15 (WDC2730/36/42H) | A | A | A | A | A | A | A | A | 12.0 | |
| GLASS INSERT - NOT TEMPERED - GRID PATTERN | | | | | | | | | | | | |
|  | Use on WM****H Cab. In Red (K): For K8, K3 & K10 Cab. *Two Separate Glass Inserts for WM24 & 27** Cab. Note: Caution When Shipping | GI-12/24*30 (WM1230/2430-01) | A | A | A | A | A | A | A | A | 5.0 | |
| | | GI-12/24*30-K (WM1230/2430-01) | A | A | A | A | A | A | A | A | A | 5.0 |
| | | GI-12/24*36 (WM1236/2436-01) | A | A | A | A | A | A | A | A | A | 5.0 |
| | | GI-12/24*36-K (WM1236/2436-01) | A | A | A | A | A | A | A | A | A | 5.0 |
| | | GI-12/24*42 (WM1242/2442-01) | A | A | A | A | A | A | A | A | A | 5.0 |
| | | GI-12/24*42-K (WM1242/2442-01) | A | A | A | A | A | A | A | A | A | 5.0 |
| | | GI-15/30*30 (WM1530/3030-01) | A | A | A | A | A | A | A | A | A | 5.0 |
| | | GI-15/30*30-K (WM1530/3030-01) | A | A | A | A | A | A | A | A | A | 5.0 |
| | | GI-15/30*36 (WM1536/3036-01) | A | A | A | A | A | A | A | A | A | 5.0 |
| | | GI-15/30*36-K (WM1536/3036-01) | A | A | A | A | A | A | A | A | A | 5.0 |
| | | GI-15/30*42 (WM1542/3042-01) | A | A | A | A | A | A | A | A | A | 5.0 |
| | | GI-15/30*42-K (WM1542/3042-01) | A | A | A | A | A | A | A | A | A | 5.0 |
| GI-18*30 (WM1830-01) | A | A | A | A | A | A | A | A | A | 5.0 | | |
| GI-18*30-K (WM1830-01) | A | A | A | A | A | A | A | A | A | 5.0 | | |
| GI-18*36 (WM1836-01) | A | A | A | A | A | A | A | A | A | 5.0 | | |
| GI-18*36-K (WM1836-01) | A | A | A | A | A | A | A | A | A | 5.0 | | |
| GI-18*42 (WM1842-01) | A | A | A | A | A | A | A | A | A | 5.0 | | |
| GI-18*42-K (WM1842-01) | A | A | A | A | A | A | A | A | A | 5.0 | | |
| GI-27*30 (WM2730-01)* | A | A | A | A | A | A | A | A | A | 5.0 | | |
| GI-27*30-K (WM2730-01)* | A | A | A | A | A | A | A | A | A | 5.0 | | |
| GI-27*36 (WM2736-01)* | A | A | A | A | A | A | A | A | A | 5.0 | | |
| GI-27*36-K (WM2736-01)* | A | A | A | A | A | A | A | A | A | 5.0 | | |
| GI-27*42 (WM2742-01)* | A | A | A | A | A | A | A | A | A | 5.0 | | |
| GI-27*42-K (WM2742-01)* | A | A | A | A | A | A | A | A | A | 5.0 | | |

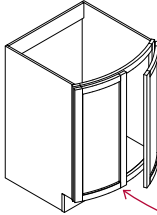
A: Available to Order N: Not Available C: Call First

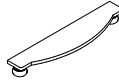
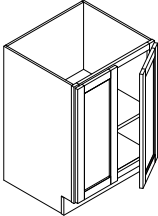
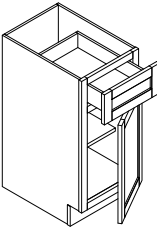
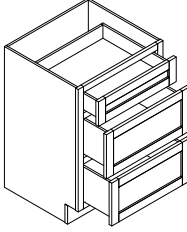
| | | ITEM CODE | K10 | M01 | A7 | K3 / K3 | CO66 | J5 | S1 | S8 | WT/LB |
|---|---|--|-----|-----|----|---------|------|----|----|----|-------|
| VANITY - BASE CABINET | | SVA24 | A | A | A | A | A | A | N | N | 35.0 |
|  | 33" High 21" Deep 2 Curved Doors: 27-3/4" H No Shelf Note: Back Panel Already Cut for Plumbing | <p style="text-align: center;">SOLD SEPERATELY</p>   <p>*24 (See Pg.43) *30 (See Pg.43)</p> <p style="text-align: center;">Decor Foot Available</p> | | | | | | | | | |
| VANITY - BASE CABINET | | SVA24P | A | A | A | A | A | A | A | A | 41.0 |
|  | 33" High 21" Deep 2 Doors: 27-3/4" H 1 Shelf Note: Not Cut for Plumbing | | | | | | | | | | |
| VANITY - BASE CABINET | | SVA09P | A | A | A | A | A | A | A | A | 29.0 |
|  | 33" High 21" Deep 1 Drawer 1 Door 1 adj. shelf | SVA12P | C | C | C | C | C | C | C | C | 34.0 |
| | | SVA15P | C | C | C | C | C | C | C | C | 41.0 |
| | | SVA18P | C | C | C | C | C | C | C | C | 47.0 |
| | | SVA21P | C | C | C | C | C | C | C | C | 55.0 |
| | | | | | | | | | | | |
| VANITY - BASE CABINET | | SVA09D | A | A | A | A | A | A | A | A | 42.0 |
|  | 33" High 21" Deep 1 Small Drawer 2 Large Drawer | SVA12D | A | A | A | A | A | A | A | A | 50.0 |
| | | SVA15D | A | A | A | A | A | A | A | A | 58.0 |
| | | SVA18D | A | A | A | A | A | A | A | A | 63.0 |
| | | SVA21D | A | A | A | A | A | A | A | A | 68.0 |
| | | SVA24D | A | A | A | A | A | A | A | A | 73.0 |
| | | | | | | | | | | | |

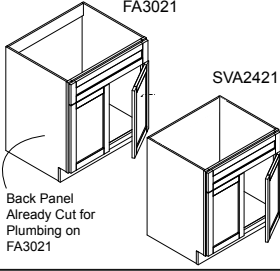
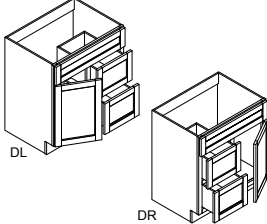
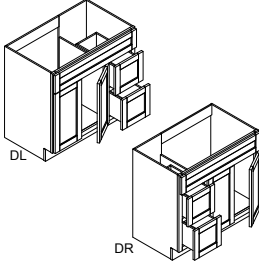
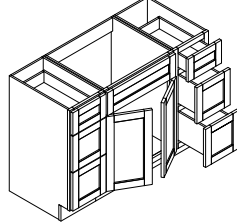
| | | ITEM CODE | K10 | M01 | A7 | K3 / K3 | CO66 | J5 | S1 | S8 | WT/LB |
|---|---|---|-----|-----|----|---------|------|----|----|----|-------|
| VANITY - SINK CABINET | | SVA2421 | C | C | C | C | C | C | C | C | 38.0 |
|  | FA3021 33" High 21" Deep 1 Dummy Drawer 2 Doors No Shelf Note: Back Panel Already Cut for Plumbing on FA3021 | FA3021 | A | A | A | A | A | A | A | A | 40.0 |
| | | Back Panel Already Cut for Plumbing on FA3021 | | | | | | | | | |
| VANITY SINK CABINET COMBO | | FA3021DL | A | A | A | A | A | A | A | A | 65.0 |
|  | 33" High 21" Deep 1 Dummy Drawer 2 Drawers: 12" W 1 Doors: 18" W No Shelf *Door on Right Note: Back Panel Already Cut for Plumbing | FA3021DR* | A | A | A | A | A | A | A | A | 65.0 |
| | | | | | | | | | | | |
| VANITY SINK CABINET COMBO | | FA3621DL | A | A | A | A | A | A | A | A | 67.0 |
|  | 33" High 21" Deep 1 Dummy Drawer 2 Drawers: 12" W 2 Doors: 12" W No Shelf *Door on Right Note: Back Panel Already Cut for Plumbing | FA3621DR* | A | A | A | A | A | A | A | A | 67.0 |
| | | | | | | | | | | | |
| VANITY SINK CABINET COMBO | | FA4821D | A | A | A | A | A | A | A | A | 102.0 |
|  | 33" High 21" Deep 1 Dummy Drawer 6 Drawers: 12" W 2 Doors: 12" on FA4821D 18" on FA6021D No Shelf Note: Back Panel Already Cut for Plumbing | FA6021D | A | A | A | A | A | A | A | A | 120.0 |
| | | | | | | | | | | | |



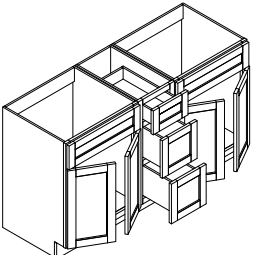
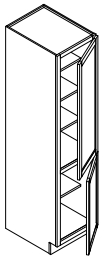
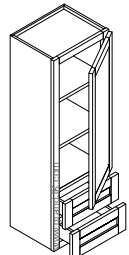
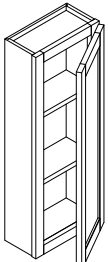

Note: Style and product availability may vary slightly from those shown in this catalog due to material availability and/or improvements to our designs. Specifications are subject to change without notice. Finger joint technique is used in some of our molding and decorative items, which is acceptable in industry standard. Natural variations of wood make the possibility of the finger joints visible. There is 1/4" to 1/2" deviation on all vanity cabinets. Check with your sales representative for product specification before planning your projects.

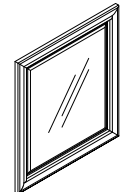
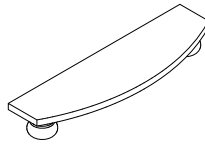
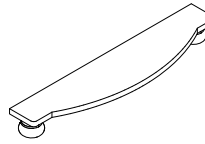
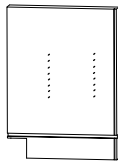
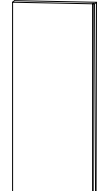

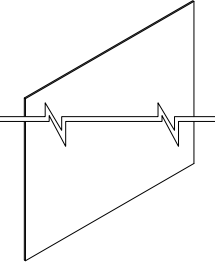
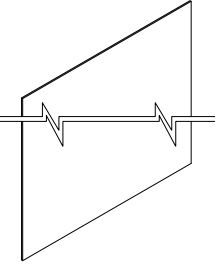

A: Available to Order N: Not Available C: Call First

| | | ITEM CODE | K10 | M01 | A7 | K8 / K3 | CO66 | J5 | S1 | S8 | WT/LB | | | | | | | | | | | | |
|--|--|-------------|----------------------|------|----------------------|---------|---------------|------|---------------|------|-------------|-----------|-------------|-----------|--|--|--|--|--|--|--|--|--|
| VANITY SINK CABINET COMBO | | | | | | | | | | | | | | | | | | | | | | | |
|  <p>33" High 21" Deep 2 Dummy Drawers 3 Drawers: 12" W 4 Doors: 12" W</p> <p>No Shelf</p> | FA6021DD | A | A | A | A | A | A | A | A | A | 138.0 | | | | | | | | | | | | |
| | | | | | | | | | | | | | | | | | | | | | | | |
| VANITY LINEN CABINET | | | | | | | | | | | | | | | | | | | | | | | |
|  <p>18" Wide 81" High 24" Deep 2 Doors: 47-7/8" & 27-3/4" 4 Shelves</p> | SVA188124P | A | A | A | A | A | A | A | A | A | 96.0 | | | | | | | | | | | | |
| | | | | | | | | | | | | | | | | | | | | | | | |
| VANITY COUNTERTOP LINEN CABINET | | | | | | | | | | | | | | | | | | | | | | | |
|  <p>12" W x 45-1/2" H x 12" D 2 Shelves & 2 Drawers with Ball Bearing Side Glides</p> | DV1245 | A | A | A | A | A | A | A | A | A | 40.0 | | | | | | | | | | | | |
| | <table border="1"> <tr> <td colspan="2">J5, CO66, S1, S8</td> <td colspan="2">K10, M01, A7, K8, K3</td> </tr> <tr> <td>Drawer Height</td> <td>7" H</td> <td>Drawer Height</td> <td>6" H</td> </tr> <tr> <td>Door Height</td> <td>30-1/2" H</td> <td>Door Height</td> <td>32-1/2" H</td> </tr> </table> | | J5, CO66, S1, S8 | | K10, M01, A7, K8, K3 | | Drawer Height | 7" H | Drawer Height | 6" H | Door Height | 30-1/2" H | Door Height | 32-1/2" H | | | | | | | | | |
| | J5, CO66, S1, S8 | | K10, M01, A7, K8, K3 | | | | | | | | | | | | | | | | | | | | |
| | Drawer Height | 7" H | Drawer Height | 6" H | | | | | | | | | | | | | | | | | | | |
| Door Height | 30-1/2" H | Door Height | 32-1/2" H | | | | | | | | | | | | | | | | | | | | |
| | | | | | | | | | | | | | | | | | | | | | | | |
| VANITY MEDICINE CABINET | | | | | | | | | | | | | | | | | | | | | | | |
|  <p>12" Wide 33" High 6" Deep 1 Door 2 Adj. Shelves</p> | W V1233 6 | A | A | A | A | A | A | A | A | A | 16.0 | | | | | | | | | | | | |
| | | | | | | | | | | | | | | | | | | | | | | | |

| | | ITEM CODE | K10 | M01 | A7 | K8 / K3 | CO66 | J5 | S1 | S8 | WT/LB |
|--|----------------|-----------|-----|-----|----|---------|------|----|----|----|-------|
| VANITY MIRROR | | | | | | | | | | | |
|  <p>Wooden Frame</p> <p>Beveled Edge Mirror Not Tempered</p> <p>Note: Hanging Hardware Not Included</p> | SVAM2427 | A | A | A | A | A | A | A | A | A | 15.0 |
| | SVAM3027 | A | A | A | A | A | A | A | A | A | 18.0 |
| DECORATIVE FOOT & SUPPORT | | | | | | | | | | | |
|  <p>24" Wide 7" Deep 4-1/2" High</p> <p>Note: Use It with Vanity Base 24" (SVA24)</p> | *24 | A | A | A | A | A | A | N | N | | 3.5 |
| | | | | | | | | | | | |
| DECORATIVE FOOT & SUPPORT | | | | | | | | | | | |
|  <p>30" Wide 7" Deep 4-1/2" High</p> <p>Note: Use It with Vanity Base 24" (SVA24)</p> | *30 | A | A | A | A | A | A | N | N | | 4.0 |
| | | | | | | | | | | | |
| PART - CABINET SIDE PANEL-FINISHED (L&R) | | | | | | | | | | | |
|  <p>23-1/5" W 34-1/2" H 1/2" Thick</p> <p>Matching Finished on One Side Pre-cut Toe Kick Pre-drilled Shelf Holes Dadoed for Bottom Panel Dadoed for Back Panel</p> | Part-CSP | C | C | C | C | C | C | C | C | C | 3.0 |
| | | | | | | | | | | | |
| PART - CABINET SIDE PANEL | | | | | | | | | | | |
|  <p>18", 27" Wide 96" H 1/2" Thick</p> <p>Both Side Clear Coat Finish</p> <p>Dadoed for Back Panel</p> | Part-CSP 18*96 | C | | | | | | | | | 20.0 |
| | Part-CSP 27*96 | C | | | | | | | | | 30.0 |

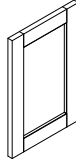







A: Available to Order N: Not Available C: Call First





| | | ITEM CODE | K10 | M01 | A7 | K3 / K3 | CO66 | J5 | S1 | S8 | WT/LB |
|---|--|------------------------------------|-----|-----|----|---------|------|----|----|----|--------------|
| PART - CABINET BOTTOM PANEL | | | | | | | | | | | |
|  | 36" W 96" H 1/2" Thick Both Side Clear Coat Finish | Part-CBP-36*96 | | C | | | | | | | 39.0 |
| PART - CABINET SHELF | | | | | | | | | | | |
|  | Wood Shelf 22-1/2" or 25-1/2" Wide 96" High 5/8" Thick Clear Coat Finish 4 Side Edge Banded | Part-WS 22.5*96 Part-WS 25.5*96 | | C | | | | | | | 28.0 28.0 |
| TOUCH UP | | | | | | | | | | | |
|  | Wax Stick | FIL-STIK | A | A | A | A | A | A | A | A | 0.1 |
| TOUCH UP | | | | | | | | | | | |
|  | Marker | MARKER | A | A | A | A | A | A | A | A | 0.1 |
| TOUCH UP | | | | | | | | | | | |
|  | Stain or Lacquer 4 OZ. Can | STAIN/LACQUER | A | A | A | A | A | A | A | A | 0.6 |
| SAMPLE MOLDING BOX | | | | | | | | | | | |
|  | Assorted Moldings 4" - 6"/ea. | SAMPLE MOLDING BOX | | C | | | | | | | 5.0 |

| | | ITEM CODE | K10 | M01 | A7 | K3 / K3 | CO66 | J5 | S1 | S8 | WT/LB |
|---|---|----------------|-----|-----|----|---------|------|----|----|----|-------|
| SAMPLE DOOR | | | | | | | | | | | |
|  | 11-3/4" W 14-1/2" H 3/4" Thick | SAMPLE DOOR | A | A | A | A | A | A | A | A | 1.0 |
| DRAWER GLIDE - FULL EXTENSION SOFT-CLOSE UNDERMOUNT | | | | | | | | | | | |
|  | Steel Capacity: 75 lbs for 9" - 24" Base | UMFE 15"-S (H) | | C | | | | | | | 3.5 |
| | | UMFE 18"-S | | C | | | | | | | 4.2 |
| | | UMFE 21"-S | | C | | | | | | | 5.5 |
| DRAWER GLIDE - FULL EXTENSION BALL BEARING SIDE MOUNT | | | | | | | | | | | |
|  | Steel Capacity: 75 lbs for 9" - 24" Base *S: Soft-Close | BBG10" | | C | | | | | | | 3.8 |
| | | BBG14" | | C | | | | | | | 5.5 |
| | | BBG14"-S | | C | | | | | | | 5.5 |
| | | BBG16" | | C | | | | | | | 6.2 |
| | | BBG16"-S | | C | | | | | | | 6.5 |
| | | BBG18" | | C | | | | | | | 7.8 |
| | | BBG20" | | C | | | | | | | 8.2 |
| | | BBG20"-S | | C | | | | | | | 8.6 |
| | | BBG22" | | C | | | | | | | 9.8 |
| | | BBG22"-S | | C | | | | | | | 10.2 |
| | | BBG26" | | C | | | | | | | 10.3 |
| HINGE | | | | | | | | | | | |
|  | Metal Concealed Soft-close 6 Way Adj. | 0803-New | | C | | | | | | | 0.3 |

Note: Style and product availability may vary slightly from those shown in this catalog due to material availability and/or improvements to our designs. Specifications are subject to change without notice. Finger joint technique is used in some of our molding and decorative items, which is acceptable in industry standard. Natural variations of wood make the possibility of the finger joints visible. There is 1/4" to 1/2" deviation on all vanity cabinets. Check with your sales representative for product specification before planning your projects.

A: Available to Order N: Not Available C: Call First

| | | ITEM CODE | K10 | M01 | A7 | K8 / K3 | CO66 | J5 | S1 | S8 | WT/LB |
|---|--|-----------|-----|-----|----|---------|------|----|----|----|-------|
| HINGE - BI-FOLDING | | | | | | | | | | | |
|  | Metal - Concealed For Bi-folding Doors Open 165 Degree Use It on LS3612 | 0804 | | | | | | | | C | 0.3 |
| HINGE - FRAME & DOOR | | | | | | | | | | | |
|  | Metal - Concealed Connecting Frame & Door Use It on LS3612 | 0805 | | | | | | | | C | 0.4 |
| HINGE - UPWARD OPENING | | | | | | | | | | | |
|  | Pneumatic Lift | 0806 | | | | | | | | C | 0.3 |
| LAZY SUAN TURN PLATE | | | | | | | | | | | |
|  | Lazy Susan Turn Plate Metal (Black) 6" x 6" | 620 | | | | | | | | C | 1.0 |
| SHELF REST - FOR GLASS SHELF ALSO | | | | | | | | | | | |
|  | Rubber Shelf Rest 3/16" Hole | 8801 | | | | | | | | C | 0.01 |
| SOUND DAMPENING DOOR BUMPER (Sold in Bulk 50/Sheet) | | | | | | | | | | | |
|  | Clear Rubber 3/8" x 1/2" | 8803 | | | | | | | | C | 0.01 |
| RETAINER CLIP - FOR GLASS INSERT | | | | | | | | | | | |
|  | Retainer Clip for Glass Insert 3/4" x 3/8" x 3/8" | 8801A | | | | | | | | C | 0.01 |
| L - BRACKET-90 DEGREE | | | | | | | | | | | |
|  | Metal 7/8" x 2-1/8" x 2-1/8" | 9810 | | | | | | | | C | 0.1 |
| L - BRACKET 135 DEGREE | | | | | | | | | | | |
|  | Metal 5/8" x 1-7/8" x 1-7/8" | 9800 | | | | | | | | C | 0.1 |

| | | ITEM CODE | K10 | M01 | A7 | K8 / K3 | CO66 | J5 | S1 | S8 | WT/LB |
|---|--|-----------|-----|-----|----|---------|------|----|----|----|-------|
| TRASH BIN - PLASTIC | | | | | | | | | | | |
|  | Gray 7 Gallon Use It on BWBK18-2 | 6910 | | | | | | | | C | 3.0 |
| STEEL KNOB (Sold in Bulk 20/Box) | | | | | | | | | | | |
|  | Satin Nickel 1-3/16" Zinc Die Cast Screw Not Included | SN-B-3910 | | | | | | | | C | 0.3 |
| PULL -STEEL (Sold in Bulk 20/Box) | | | | | | | | | | | |
|  | Stainless Steel 4-3/4" L x 1-1/4" H 15/32" Dia. Screw Not Included | T12073 | | | | | | | | C | 0.3 |
| PULL - STEEL (Sold in Bulk 20/Box) | | | | | | | | | | | |
|  | Stainless Steel 6-1/8" L x 1-1/4" H 15/32" Dia. Screw Not Included | T15696 | | | | | | | | C | 0.4 |
| PULL - STEEL (Sold in Bulk 20/Box) | | | | | | | | | | | |
|  | Stainless Steel 7-3/8" L x 1-1/4" H 15/32" Dia. Screw Not Included | T188128 | | | | | | | | C | 0.4 |

A: Available to Order N: Not Available C: Call First